

M12 MALE 0° SHIELDED

PUR 4X0.34 shielded GRAY, UL/CSA 15m

Male straight

M12, 4-pole

A-coded

shielded

Plastic housings with good resistance against chemicals and oils.

The resistance to aggressive media should be individually tested for your application. Further details on request.

Further cable lengths on request.

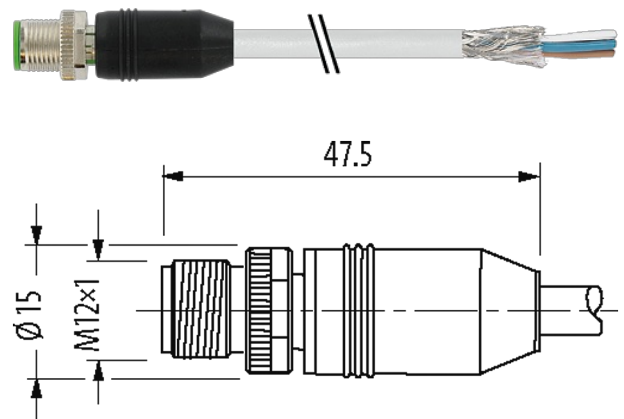
Illustration

Product may differ from Image

Approvals

* only for products with UL/CSA approved cable

cCSAus

EAC

Form

Form 13081

Cables

No./diameter of wires	4 x 0.34 mm ²
Wire isolation	PP (br, wh, bl, bk)
Material (jacket)	PUR (UL/CSA)
Outer Ø	5.9 mm ±5%
Bend radius (moving)	10× outer Ø
Temperature range (fixed)	-40...+80 °C
Temperature range (mobile)	-20...+80 °C
Cable identification	335
Cable Type	PUR-OB
Approval (cable)	UL (AWM-Style 20233/1992), CSA; CE conform
Cable weight [g/m]	56,10
Material (wire)	Cu wire, bare
Resistor (core)	max. 52 Ω/km (20 °C)
Single wire Ø (core)	0.1 mm
Diameter (core)	4 x 0.34 mm ²

Material (wire isolation)	PP
Material property (wire isolation)	CFC-, halogen-, cadmium-, silicone- and lead-free
Shore hardness (wire isolation)	72 ±3 D
Wire-Ø incl. isolation	1.55 mm ±5%
Color/numbering of wires	br, bk, bl, wh
Stranding combination	4 wires twisted
Shield	yes
	min. 85%
Material (jacket)	PUR
Shore hardness (jacket)	85 ±3 A
Outer-Ø (jacket)	5.9 mm ±5%
Color (jacket)	gray
chemical resistance	good resistance to oil, gasoline and chemicals (VDE 0472 Teil 803 Test B)
thermal resistance	flame retardant UL VW1, CSA FT1
Nominal voltage	300 V AC
Test voltage	2000 V AC
Temperature range (fixed)	-40...+80 °C
Temperature range (mobile)	-20...+80 °C
Bend radius (fixed)	10× outer Ø
Jacket Color	gray

Technical Data

Operating voltage	max. 60 V AC/DC
Operating voltage (only UL listed)	max. 30 V AC/DC
Rated surge voltage	1.5 kV
Operating current per contact	max. 4 A
No. of poles	4
Material group	IEC 60664-1, category I
Coding	A-coded
LED display	no
Locking of ports	Screw thread (M12×1 mm) recommended torque 0.6 Nm, self-securing
Compression gland	M12 (SW13)
Protection	IP65, IP66K, IP67 inserted and tightened (EN 60529)
Material	PUR
Locking material	Zinc die casting, matte nickel plated

General data

Standards	DIN EN 61076-2-101 (M12)
Mounting method	inserted, tightened
Material (contact)	Copper alloy
Material (contact surface)	Au
Pollution Degree	3
Stripping length (jacket)	20 mm
Temperature range	-25...+85 °C, depending on cable quality

Commercial data

country of origin	DE
customs tariff number	85444290
EAN	4048879201186
eClass	27279218
Packaging unit	1

Sketch

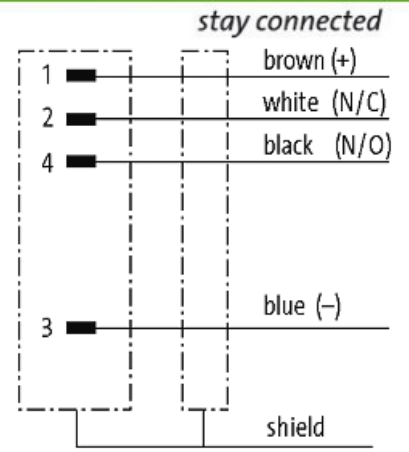

Male



Product may differ from Image